

PRODUCT NAME: Pyramid LED Flush Mount
ITEM NUMBER: E20810

Please consult your electrician for hanging fixture and wiring.

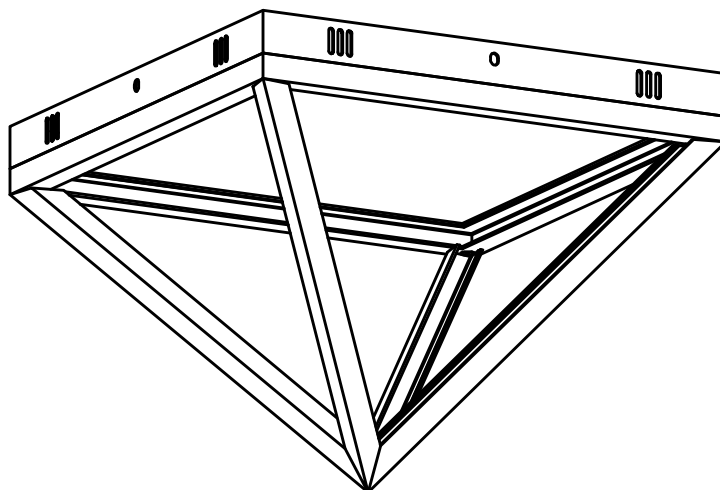

WARNING: Wires need to be connected to driver found in canopy and should not be connected directly to power source or a short may occur.

The fixture is designed to dim with a standard Triac forward phase dimmer.

Dimming levels will vary by dimmer.

Below is a list of recommended dimmers:

Lutron MACL-153M

Lutron DVL-153P

Lutron SCL-153P

Leviton IPL06-10Z

Leviton 6674-POW

Due to inrush current wattage should not exceed 150 watts of product for a 600 watt dimmer.

LED 20W

IMPORTANT: Turn off the power at the main fuse or circuit breaker box before starting installation

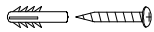

Screws*4PCS

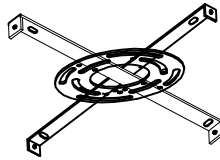

Bracket



Mounting Screws*4PCS

Locate all hardware & components before discarding packaging

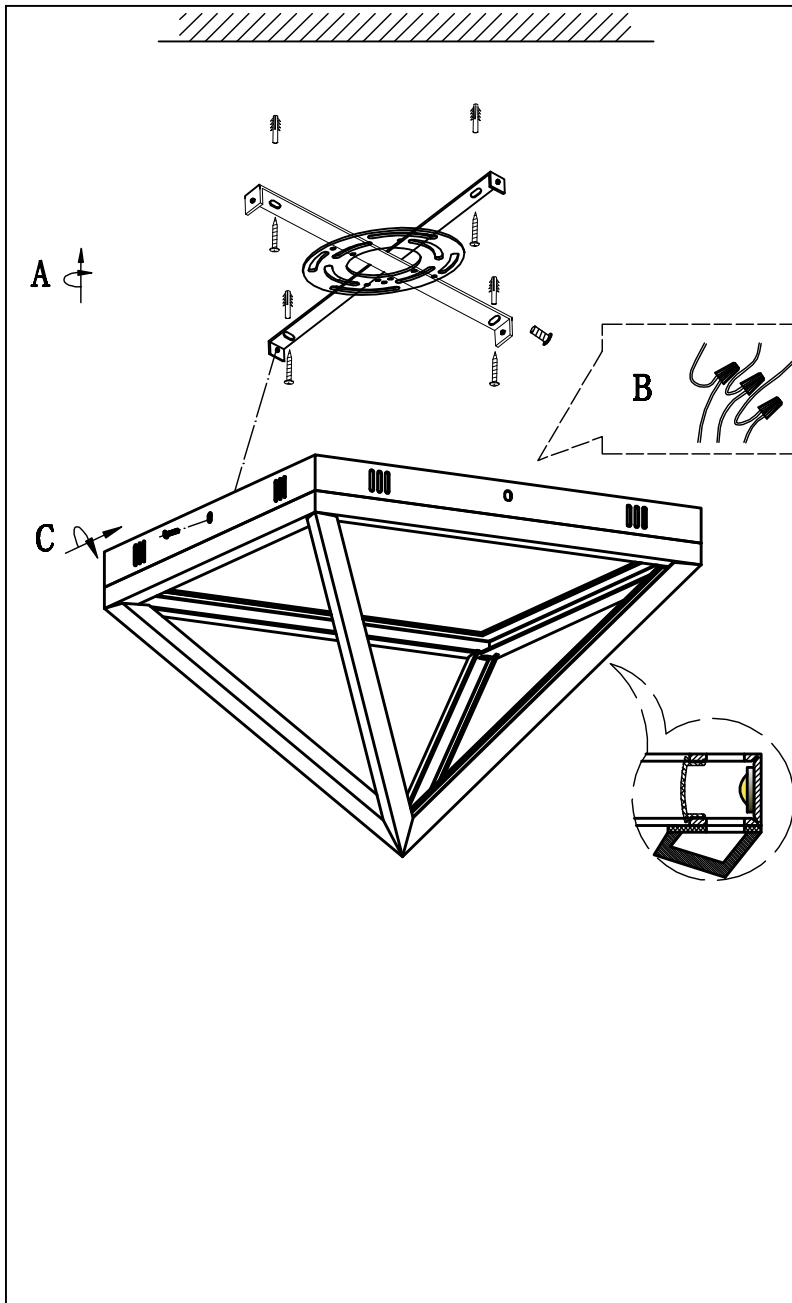

1.)

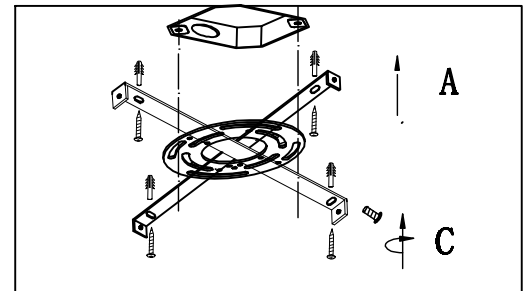

Step 1: Remove mounting bracket from fixture and install to electrical box.

2.)

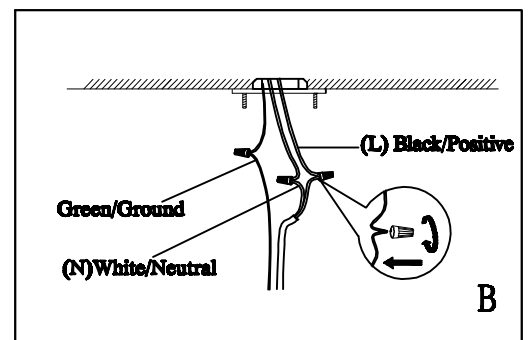

Step 2: Then wire fixture to wires in outlet box. Copper wire is for Ground. install lamp body to mounting bracket using two screws on side.

Cleaning & Care:
Clean with soft cloth and a mild detergent.
Do not use abrasive cleaner.